

greenworks

pro™

**BL60B00
BL60B210**

**ULTRAPOWER™
60V**

EN

BLOWER

OPERATOR MANUAL

ES

SOPLADOR

MANUAL DEL OPERADOR



BLC361

www.greenworkstools.com

1	Description.....	2	10.4	Remove the battery pack.....	5
1.1	Purpose.....	2	11	Operation.....	5
1.2	Overview.....	2	11.1	Start the machine.....	5
2	Important safety instructions.....	2	11.2	Stop the machine.....	5
3	Battery-operated power tools.....	2	11.3	Cruise control lever.....	5
4	Child safety.....	3	11.4	Turbo button.....	6
5	Proposition 65.....	3	11.5	Operation tips.....	6
6	Save these instructions.....	3	12	Maintenance.....	6
7	Symbols on the product.....	3	12.1	Clean the machine.....	6
8	Risk levels.....	4	13	Transportation and storage.....	6
9	Environmentally safe battery disposal.....	4	13.1	Move the machine.....	6
10	Installation.....	4	13.2	Store the machine.....	6
10.1	Unpack the machine.....	4	14	Troubleshooting.....	6
10.2	Install the blower tube.....	5	15	Technical data.....	7
10.3	Install the battery pack.....	5	16	Limited warranty.....	7
			17	Exploded view.....	7

1 DESCRIPTION

1.1 PURPOSE

The machine is used to propel air out of a tube to move unwanted materials such as leaves in the yard. Some machines also suck in leaves and small twigs through a vacuum, and shred them into a bag.

1.2 OVERVIEW

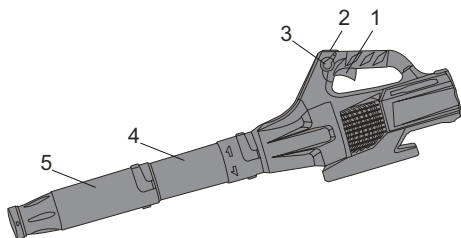

- | | |
|------------------------|--------------|
| 1 Trigger | 4 Rear tube |
| 2 Turbo button | 5 Front tube |
| 3 Cruise control lever | |

2 IMPORTANT SAFETY INSTRUCTIONS

For household use.

READ ALL INSTRUCTIONS BEFORE USING (THIS POWER TOOL)

▲ WARNING

Read and understand all instructions before using this product. Failure to follow all instructions listed below may result in electric shock, fire, and/or serious personal injury. When using an electrical appliance, basic precautions should always be followed, including the following:

- Do not use on wet surfaces.
- Do not charge the unit outdoors.
- Do not allow to be used as a toy. Close attention is necessary when used by or near children.
- Use only as described in this manual. Use only manufacturer's recommended attachments.
- If appliance is not working as it should, has been dropped, damaged, left outdoors, or dropped into water, return it to a service center.
- Do not handle appliance with wet hands.
- Do not put any object into openings. Do not use with any opening blocked; keep free of dust, lint, hair, and anything that may reduce air flow.
- Keep hair, loose clothing, fingers and all body parts away from openings and moving parts.
- Use extra care when cleaning on stairs.

- Do not operate power tools in an explosive atmosphere, such as in the presence of flammable liquids, gases, or dust. Power tools create sparks that may ignite the dust or fumes.
- Never allow children to operate the equipment. Never allow adults to operate the equipment without proper instruction.
- Wear heavy long pants, boots, and gloves. Avoid loose garments or jewellery that could get caught in moving parts of the machine or its motor.
- Do not force tool. Use the correct tool for your application. The correct tool will do the job better and safer at the rate for which it is designed.
- Keep firm footing and balance. Do not overreach. Overreaching can result in loss of balance.
- Do not use the tool if the switch does not turn it on or off. Any tool that cannot be controlled with the switch is dangerous, and must be repaired.
- Do not operate this unit when you are tired, ill, or under the influence of alcohol, drugs, or medication.
- Do not operate in poor lighting.
- Do not use to pick up flammable or combustible liquids, such as gasoline, or use in areas where they may be present
- Do not pick up anything that is burning or smoking, such as cigarettes, matches, or hot ashes.
- Do not use without dust bag and/or filters in place (if applicable).
- Check the work area before each use. Remove all objects such as rocks, broken glass, nails, wire, or string which can be thrown or become entangled in the machine.
- Use only identical manufacturer's replacement parts and accessories. Use of any other parts may create a hazard or cause product damage.
- To Reduce The Risk Of Electric Shock – Do Not Expose To Rain – Store Indoors.
- Use only with LB602, LB6025, LB603, LB604, LB605, LB606 and other BAC battery packs.
- Use only with CAC801, CH60DP01, 60DPC10A, CH60R00 and other CAC chargers.

3 BATTERY-OPERATED POWER TOOLS

- Do not use battery-operated appliance in rain.
- Turn off all controls before removing the battery.
- Recharge only with the charger specified by the manufacturer. A charger that is suitable for one type of battery pack may create a risk of fire when used with another battery pack.
- Use only the charger supplied by the manufacturer to recharge.
- Use appliances only with specifically designated battery packs. Use of any other battery packs may create a risk of injury and fire.

- Prevent unintentional starting. Ensure the switch is in the off-position before connecting to battery pack, picking up or carrying the appliance. Carry the power tool with your finger on the switch or energize power tool that have the switch on invites accidents.
- Disconnect the battery pack from the power tool before making any adjustments, changing accessories, or storing the power tool. Such preventive safety measures reduce the risk of starting the power tool accidentally.
- When battery pack is not in use, keep it away from other metal objects like paper clips, coins, keys, nails, screws or other small metal objects that can make a connection from one terminal to another. Shorting the battery terminals together may cause burns or a fire.
- Under abusive conditions, liquid may be ejected from the battery; avoid contact. If contact accidentally occurs, flush with water. If liquid contacts eyes, additionally seek medical help. Liquid ejected from the battery may cause irritation or burns.
- Do not incinerate the appliance even if it is severely damaged. The batteries can explode in a fire.
- Do not use a battery pack or appliance that is damaged or modified. Damaged or modified batteries may exhibit unpredictable behavior resulting in fire, explosion or risk of injury.
- Do not expose a battery pack or appliance to fire or excessive temperature. Exposure to fire or temperature above 265°F (130°C) may cause an explosion.
- Have servicing performed by a qualified repair person using only identical replacement parts. This will ensure that the safety of the product is maintained.
- Don't modify or attempt to repair the appliance or the battery pack (as applicable) except as indicated in the instructions for use and care.
- Follow all charging instructions and do not charge the battery pack or appliance outside of the temperature range specified in the instructions. Charging improperly or at temperatures outside of the specified range may damage the battery and increase the risk of fire.

4 CHILD SAFETY

Tragic accidents can occur if the operator is not aware of the presence of children.

- Keep children out of the working area and under the watchful care of a responsible adult.
- Do not allow children under the age of 14 to operate this machine. Children who are 14 years of age and older must read and understand the operating instructions and safety rules in this manual and must be trained and supervised by a parent.
- Stay alert, and turn the machine off if a child or any other person enters the working area.
- Use extreme care when approaching blind corners, doorways, shrubs, trees, or other objects that may obscure your view of a child who may run into the path of the machine.

5 PROPOSITION 65

▲ WARNING

This product contains a chemical known to the state of California to cause cancer, birth defects or other reproductive harm. Some dust created by power sanding, sawing, grinding, drilling, and other construction activities contains chemicals known to cause cancer, birth defects or other reproductive harm. Some examples of these chemicals are:





- Lead from lead-based paints;
- Crystalline silica from bricks and cement and other masonry products;
- Arsenic and chromium from chemically treated lumber.





Your risk of exposure to these chemicals varies depending on how often you do this type of work. To reduce your exposure to these chemicals, work in a well-ventilated area, and work with approved safety equipment, such as dust masks that are specially designed to filter out microscopic particles.

6 SAVE THESE INSTRUCTIONS

7 SYMBOLS ON THE PRODUCT



Some of the following symbols may be used on this tool. Please study them and learn their meaning. Proper interpretation of these symbols will allow you to operate the tool better and safer.

Symbol	Explanation
V	Voltage
A	Current
W	Power
min	Time
/min	Revolutions, strokes, surface speed, orbits etc., per minute
	Direct current
	Read and understand all instructions before operating the product, and follow all warnings and safety instructions.
	Precautions that involve your safety.
	Always wear eye protection with side shields marked to comply with ANSI Z87.1 when operating this equipment.
	Do not expose the product to rain or moist conditions.

Symbol	Explanation
	Keep all bystanders at least 50 feet away.
	Failure to keep loose clothing from being drawn into air intake could result in personal injury.
	Failure to keep long hair away from the air inlet could result in personal injury.
	Rotating impeller blades can cause severe injury.

8 RISK LEVELS

The following signal words and meanings are intended to explain the levels of risk associated with this product.

SYMBOL	SIGNAL	MEANING
	DANGER	Indicates an imminently hazardous situation, which, if not avoided, will result in death or serious injury.
	WARNING	Indicates a potentially hazardous situation, which, if not avoided, could result in death or serious injury.
	CAUTION	Indicates a potentially hazardous situation, which, if not avoided, may result in minor or moderate injury.
	CAUTION	(Without Safety Alert Symbol) Indicates a situation that may result in property damage.

9 ENVIRONMENTALLY SAFE BATTERY DISPOSAL



The toxic and corrosive materials below are in the batteries used in this machine: **Lithium-Ion, a toxic material.**

▲ WARNING

Discard all toxic materials in a specified manner to prevent contamination of the environment. Before discarding damaged or worn out Li-ion battery, contact your local waste disposal agency, or the local Environmental Protection Agency for information and specific instructions. Take the batteries to a local recycling and/or disposal center, certified for lithium-ion disposal.

▲ WARNING

If the battery pack cracks or breaks, with or without leaks, do not recharge it and do not use. Discard it and replace with a new battery pack. **DO NOT TRY TO REPAIR IT!** To prevent injury and risk of fire, explosion, or electric shock, and to avoid damage to the environment:

- Cover the terminals of the battery with heavy-duty adhesive tape.
- DO NOT try to remove or destroy any of the battery pack components.
- DO NOT try to open the battery pack.
- If a leak develops, the released electrolytes are corrosive and toxic. DO NOT get the solution in the eyes or on skin, and do not swallow it.
- DO NOT put these batteries in your regular household trash.
- DO NOT incinerate.
- DO NOT put them where they will become part of any waste landfill or municipal solid waste stream.
- Take them to a certified recycling or disposal center.

10 INSTALLATION

10.1 UNPACK THE MACHINE

▲ WARNING

Make sure that you correctly assemble the machine before use.

▲ WARNING

- If parts of the machine are damaged, do not use the machine.
- If you do not have all the parts, do not operate the machine.
- If the parts are damaged or missing, contact the service center.

1. Open the package.
2. Read the documentation in the box.
3. Remove all the unassembled parts from the box.
4. Remove the machine from the box.
5. Discard the box and package in compliance with local regulations.

10.2 INSTALL THE BLOWER TUBE

1. Align the grooves on the rear tube (7) with tabs (6) on the blower housing.
2. Install the rear tube (7) onto the blower housing until the tabs (6) engage the grooves.
3. Turn the rear tube in the direction of the arrow until the two tabs lock into the positions.

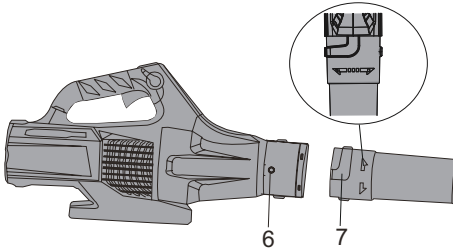

4. Connect the front tube in the same procedure above.

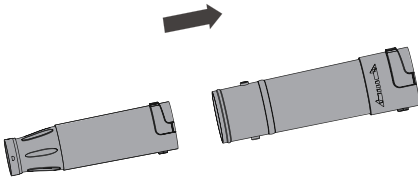

10.3 INSTALL THE BATTERY PACK

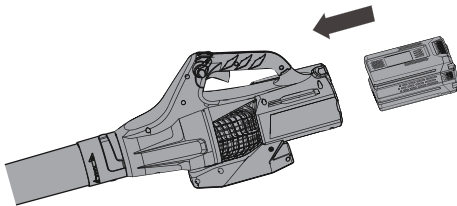

▲ WARNING

- If the battery pack or charger is damaged, replace the battery pack or the charger.
- Stop the machine and wait until the motor stops before you install or remove the battery pack.
- Read and understand the instructions in the battery and charger manual.

1. Align the lift ribs on the battery pack with the grooves in the battery compartment.
2. Push the battery pack into the battery compartment until the battery pack locks into place.
3. When you hear a click, the battery pack is installed.

10.4 REMOVE THE BATTERY PACK

1. Push and hold the battery release button.
2. Remove the battery pack from the machine.

11 OPERATION

▲ WARNING

Make sure the blower tube is in position before operation.

11.1 START THE MACHINE

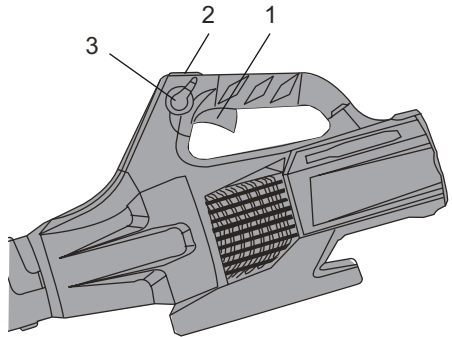

1. Pull the trigger (1) to start the machine.
2. Pull the trigger fully to increase the speed.
3. Release the trigger to decrease the speed.

11.2 STOP THE MACHINE

1. Release the trigger to stop the machine.

i NOTE

Wait until the motor stops after you stop the machine.

11.3 CRUISE CONTROL LEVER

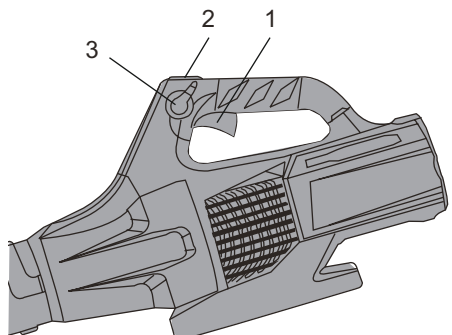

1. Pull the cruise control lever (3) clockwise to increase the speed. This will lock the speed at the desired setting.
2. Push the cruise control lever (3) counter clockwise to decrease the speed.

i NOTE
 If you decrease the speed all the way, the unit will stop and it is necessary to start the machine again.

11.4 TURBO BUTTON

1. Push the turbo button (2), the machine is at the highest speed.
2. Release the turbo button (2), the machine is at the normal speed.

i NOTE
 Using the turbo button drains the battery the fastest. Only use the turbo button when needed.

11.5 OPERATION TIPS

- Blow around the outer edge of the unwanted materials to prevent the unwanted materials from scattering.
- Use rakes and brooms to clear the unwanted material before you blow.
- Make the surfaces wet before you clear the unwanted material in dusty conditions.
- Look out for children, pets, open windows, and cleaned cars during operation.
- Clean the machine.
- Discard the unwanted material when you complete work.

12 MAINTENANCE

▲ CAUTION
 Do not let brake fluids, gasoline, petroleum-based materials touch the plastic parts. Chemicals can cause damage to the plastic, and make the plastic unserviceable.

▲ CAUTION
 Do not use strong solvents or detergents on the plastic housing or components.

▲ WARNING
 Remove the battery pack from the machine before maintenance.

12.1 CLEAN THE MACHINE

▲ CAUTION
 The machine must be dry. Humidity can cause risks of electrical shocks.

- Clear the unwanted material out of the air vent with a vacuum cleaner.
- Do not spray the air vent or put the air vent in solvents.
- Clean the housing and the plastic components with a moist and soft cloth.

13 TRANSPORTATION AND STORAGE

▲ WARNING
 Remove the battery pack from the machine before transportation and storage.

13.1 MOVE THE MACHINE

- Only hold the machine with the handgrip.

13.2 STORE THE MACHINE

- Clean the machine before storage.
- Make sure that the motor is not hot when you store the machine.
- Make sure that the machine does not have loose or damaged parts. If it is necessary, do these steps/ instructions:
 - Replace the damaged parts.
 - Tighten the bolts.
 - Speak to a person of an approved service center.
- Store the machine in a dry area.
- Make sure that children cannot come near the machine.

14 TROUBLESHOOTING

PROBLEM	POSSIBLE CAUSE	SOLUTION
The motor does not start when you pull the trigger.	The battery pack is not installed tightly.	Make sure that you tightly install the battery pack in the machine.
	The battery pack is out of power.	Charge the battery pack.
The machine does not start.	The power switch is defective.	Replace the defective parts by an approved service center.
	The motor is defective.	
	The PCB board is defective.	
The air does not flow through the tube when you start the machine.	The air inlet or tube outlet has a blockage.	Remove the blockage.

15 TECHNICAL DATA

Voltage	60 V
Air volume	450 CFM
Air speed	140 MPH
Weight (without battery pack)	5.3 lbs. (2.4 kg)
Battery model	LB602, LB6025, LB603, LB604, LB605, LB606 and other BAC series
Charger model	CAC801, CH60DP01, 60DPC10A, CH60R00 and other CAC series

The recommended ambient temperature range:

Item	Temperature
Blower storage temperature range	32°F (0°C) - 113°F (45°C)
Blower operation temperature range	32°F (0°C) - 113°F (45°C)
Battery charging temperature range	39°F (4°C) - 104°F (40°C)
Charger operation temperature range	39°F (4°C) - 104°F (40°C)
Battery storage temperature range	32°F (0°C) - 113°F (45°C)
Battery discharging temperature range	32°F (0°C) - 113°F (45°C)

16 LIMITED WARRANTY



Greenworks hereby warrants this product, to the original purchaser with proof of purchase, for a period of four (4) years against defects in materials, parts or workmanship. Greenworks, at its own discretion will repair or replace any and all parts found to be defective, through normal use, free of charge to the customer. This warranty is valid only for units which have been used for personal use that have not been hired or rented for industrial/commercial use, and that have been maintained in accordance with the instructions in the owners' manual supplied with the product from new.

ITEMS NOT COVERED BY WARRANTY:

1. Any part that has become inoperative due to misuse, commercial use, abuse, neglect, accident, improper maintenance, or alteration; or
2. The unit, if it has not been operated and/or maintained in accordance with the owner's manual; or
3. Normal wear, except as noted below;
4. Routine maintenance items such as lubricants, blade sharpening;
5. Normal deterioration of the exterior finish due to use or exposure.

HELPLINE:

Warranty service is available by calling our toll-free helpline, at 1-855-345-3934.

TRANSPORTATION CHARGES:

Transportation charges for the movement of any power equipment unit or attachment are the responsibility of the purchaser. It is the purchaser's responsibility to pay transportation charges for any part submitted for replacement under this warranty unless such return is requested in writing by Greenworks.

USA address:

Greenworks Tools

P.O. Box 1238

Mooresville, NC 28115

17 EXPLODED VIEW

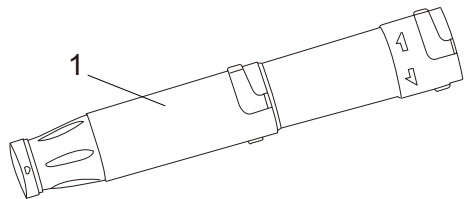

No.	Part No.	Qty	Description
1	R0201166-00	1	Round Pipe Assembly