

greenworks[®]

GPW3001

EN

PRESSURE WASHER

OPERATOR MANUAL

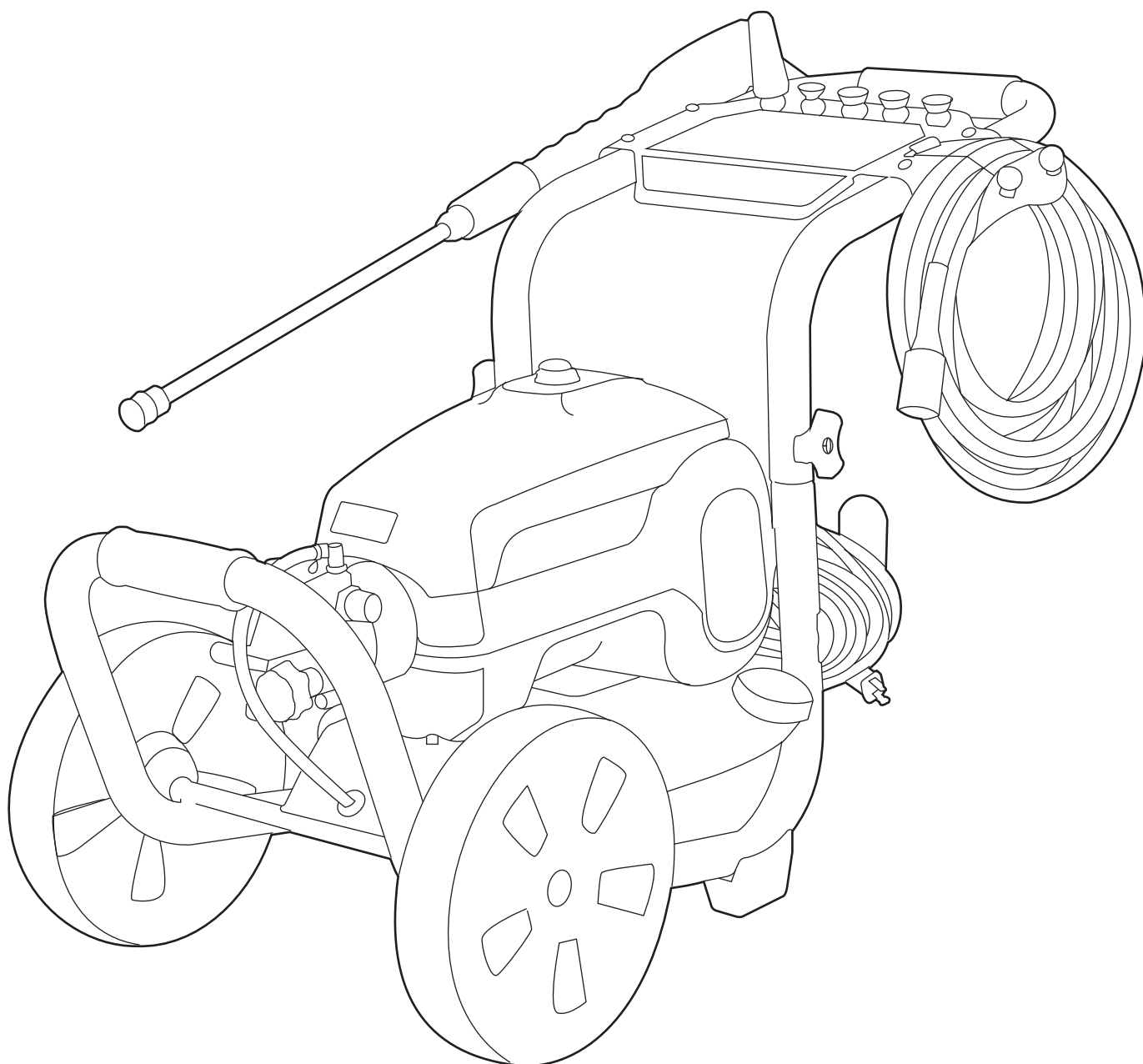

PWA211

www.greenworkstools.com

1	Description.....	4	3.6	Install the upper handle.....	8
1.1	Purpose.....	4	3.7	Install the spray wand.....	8
1.2	Overview.....	4	3.8	Install the high pressure hose.....	8
2	General power tool safety warnings.....	4	4	Operation.....	8
2.1	General power tool safety warnings.....	4	4.1	Connect the water supply to the machine.....	8
2.2	Electrical safety warnings.....	4	4.2	Use the spray gun.....	9
2.3	Pressure washer safety warnings.....	5	4.3	Change the spray tip.....	9
2.4	Ground fault circuit interrupter protection.....	5	4.4	Add detergent.....	10
2.5	Servicing of a double insulated appliance.....	5	4.5	Start the machine.....	11
2.6	Extension cords.....	5	4.6	Stop the machine.....	11
2.7	Child safety.....	5	4.7	Thermal relief valve function.....	11
2.8	Proposition 65.....	6	5	Maintenance.....	11
2.9	Symbols on the product.....	6	5.1	Spray tip maintenance.....	11
2.10	Risk levels.....	6	6	Transportation and storage.....	12
3	Installation.....	7	6.1	Move the machine.....	12
3.1	Electrical connection.....	7	6.2	Store the machine.....	12
3.2	Unpack the machine.....	7	7	Troubleshooting.....	12
3.3	Install the upper panel.....	7	8	Technical data.....	14
3.4	Install the spray gun holder.....	7	9	Limited warranty.....	14
3.5	Install the power cord storage arms.....	8	10	Exploded view.....	16

1 DESCRIPTION

1.1 PURPOSE

The machine is used to clean vehicles, boats, buildings, porches, decks, patios, and driveways.

For domestic use only, not for professional use, and for operation at temperature above 32°F (0°C).

1.2 OVERVIEW

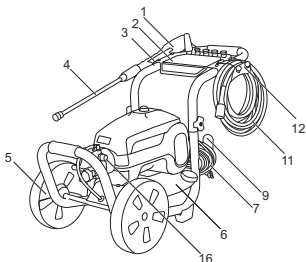

1	Spray Gun	14	GFCI
2	Upper panel	15	Knob
3	Spray gun holder	16	Water outlet
4	Spray wand	17	Garden Hose (not included)
5	Wheel	18	Spray tip
6	Detergent tank	19	Quick-connect collar
7	Power cord	20	Cleaning tool
8	Water inlet	21	Trigger safety lockout
9	Cord storage arm	22	Spray gun trigger
10	Power switch	23	Upper handle
11	High pressure hose	24	Lower handle
12	Hose hook	25	Bolt
13	Screw		

2 GENERAL POWER TOOL SAFETY WARNINGS

⚠ WARNING

When using this product basic precautions should always be followed, including the following:

Save all warnings and instructions for future reference.

The term "power tool" in the warnings refers to your mains-operated (corded) power tool.

2.1 GENERAL POWER TOOL SAFETY WARNINGS

- The machine is not intended for use by persons (including children) with reduced physical, sensory or mental capabilities, or lack of experience and knowledge, unless they have been given supervision or instruction concerning use of the machine by a person responsible for their safety. Children should be supervised to ensure that they do not play with the machine.
- Learn the machine's applications and limitations as well as the specified potential hazards related to this tool by studying this manual.
- Never operate the machine with any guard or cover removed or damaged.
- Do not operate the product while under the influence of drugs, alcohol, or any medication.
- Do not wear loose clothing, gloves, neckties, or jewelry. They can get caught and draw you into moving parts.
- Rubber gloves and non-skid footwear are recommended when working outdoors. Also wear protective hair covering to contain long hair. Wear footwear that will protect your feet and improve your grip on slippery surfaces.
- Do not overreach or stand on unstable support. Keep proper footing and balance at all times.
- Check the work area before each use. Remove all objects such as rocks, broken glass, nails, wire, or string which can be thrown or become entangled in the machine.
- Avoid dangerous environments. Do not expose to rain. Keep work area well lit.
- Before starting any cleaning operation, close doors and windows. Clear the area to be cleaned of debris, toys, outdoor furniture, or other objects that could create a hazard.
- Do not use the appliance within range of persons unless they wear protective clothing.

2.2 ELECTRICAL SAFETY WARNINGS

- Ground Fault Circuit Interrupter (GFCI) protection should be provided on the circuit(s) or outlet(s) to be used for the product.
- Disconnect from the electrical power supply before carrying out user maintenance.
- Use only extension cords that have watertight connections and are intended for outdoor use. Use only extension cords having an electrical rating not less than the rating of the product. Examine extension cord before using and replace if damaged. Do not abuse extension cord and do not pull on any cord to disconnect. Keep cord away from heat and sharp edges. Always disconnect the extension cord from the receptacle before disconnecting the product from the extension cord.

- Do not use the appliance if a supply cord or important parts of the appliance are damaged, e.g. safety devices, high-pressure hoses, trigger gun.
- Inadequate extension cords can be dangerous.
- To reduce the risk of electrocution, keep all connections dry and off the ground. Do not touch plug with wet hands.
- Do not abuse the cord. Never use the cord to carry the product or to disconnect the plug from an outlet. Keep cord away from heat, oil, sharp edges, or moving parts. Replace damaged cords immediately. Damaged cords increase the risk of electric shock.
- Inspect extension cords periodically and replace if damaged. Keep handles dry, clean, and free from oil or grease.

2.3 PRESSURE WASHER SAFETY WARNINGS

- Read all the instructions before using the product.
- To reduce the risk of injury, close supervision is necessary when a product is used near children.
- Know how to stop the product and bleed unit pressure quickly. Be thoroughly familiar with the controls.
- Stay alert – watch what you are doing.
- Do not operate the product when fatigued or under the influence of alcohol or drugs.
- Keep operating area clear of all persons.
- Do not overreach or stand on unstable support. Keep good footing and balance at all times.
- Follow the maintenance instructions specified in the manual.
- This product is provided with a ground fault circuit interrupter built into the power cord plug. If replacement of the plug or cord is needed, use only identical replacement parts.
- Risk of injection or injury– Do not direct discharge stream at persons.
- Keep the motor away from flammables and other hazardous materials.
- Keep product dry, clean, and free from oil and grease. Always use a clean cloth when cleaning. Never use brake fluids, gasoline, petroleum-based products, or any solvents to clean product.



WARNING

To reduce the risk of electrocution, keep all connections dry and off the ground. Do not touch plug with wet hands.

2.4 GROUND FAULT CIRCUIT INTERRUPTER PROTECTION

This pressure washer is provided with a ground-fault circuit-interrupter (GFCI) built into the plug of the power-supply cord. This device provides additional protection from the risk of electric shock. Should

replacement of the plug or cord become necessary, use only identical replacement parts that include GFCI protection.

2.5 SERVICING OF A DOUBLE INSULATED APPLIANCE

- Within a double insulated product, two systems of insulation are provided instead of grounding. No grounding means is provided on a double insulated product, nor should a means for grounding be added to the product. Servicing a double insulated product requires extreme care and knowledge of the system, and should be done only by qualified service personnel. Replacement parts for a double insulated product must be identical to the parts they replace. A double insulated product is marked with the words "DOUBLE INSULATION" or "DOUBLE INSULATED."

2.6 EXTENSION CORDS

- Use only extension cords that are intended for outdoor use. These extension cords are identified by a marking "Acceptable for use with outdoor appliances; store indoors while not in use." Use only extension cords having an electrical rating not less than the rating of the product. Do not use damaged extension cords. Examine extension cord before using and replace if damaged. Do not abuse extension cord and do not yank on any cord to disconnect. Keep cord away from heat and sharp edges. Always disconnect the extension cord from the receptacle before disconnecting the product from the extension cord.

2.7 CHILD SAFETY

Tragic accidents can occur if the operator is not aware of the presence of children.

- Keep children out of the working area and under the watchful care of a responsible adult.
- Do not allow children under the age of 14 to operate this machine. Children who are 14 years of age and older must read and understand the operating instructions and safety rules in this manual and must be trained and supervised by a parent.
- Stay alert, and turn the machine off if a child or any other person enters the working area.
- Use extreme care when approaching blind corners, doorways, shrubs, trees, or other objects that may obscure your view of a child who may run into the path of the machine.

2.8 PROPOSITION 65

 **WARNING**

This product contains a chemical known to the state of California to cause cancer, birth defects or other reproductive harm. Some dust created by power sanding, sawing, grinding, drilling, and other construction activities contains chemicals known to cause cancer, birth defects or other reproductive harm. Some examples of these chemicals are:





- Lead from lead-based paints;
- Crystalline silica from bricks and cement and other masonry products;
- Arsenic and chromium from chemically treated lumber.







Your risk of exposure to these chemicals varies depending on how often you do this type of work. To reduce your exposure to these chemicals, work in a well-ventilated area, and work with approved safety equipment, such as dust masks that are specially designed to filter out microscopic particles.

Save these instructions.

2.9 SYMBOLS ON THE PRODUCT



Some of the following symbols may be used on this tool. Please study them and learn their meaning. Proper interpretation of these symbols will allow you to operate the tool better and safer.

Symbol	Explanation
	To reduce the risk of injury, user must read and understand operator's manual before using this product.
	Do not expose the product to rain or moist conditions.
	Always wear safety goggles or safety glasses with side shields and, as necessary, a full face shield when operating this product.
	To reduce the risk of injection or injury, never direct a water stream towards people or pets or place any body part in the stream. Leak ing hoses and fittings are also capable of causing injection injury. Do not hold hoses or fittings.

Symbol	Explanation
	To reduce the risk of injury from kickback, hold the spray lance securely with both hands when the machine is on.
	Failure to use in dry conditions and to observe safe practices can result in electric shock.
	Fuel and its vapors are explosive and can cause severe burns or death.
	Warning! Never point the gun to human, animals, the machine body, power supply or any electric appliances.
	Appliance not suitable for connection to the drinking water mains without backflow preventer.
	Only use cleaning deck on flat, horizontal surfaces. Never lift cleaning deck from the cleaning surface while operating the pressure washer.
	Keep hands and feet away from the cleaning deck while the pressure washer is running.

2.10 RISK LEVELS

The following signal words and meanings are intended to explain the levels of risk associated with this product.

SYMBOL	SIGNAL	MEANING
	DANGER	Indicates an imminently hazardous situation, which, if not avoided, will result in death or serious injury.
	WARNING	Indicates a potentially hazardous situation, which, if not avoided, could result in death or serious injury.
	CAUTION	Indicates a potentially hazardous situation, which, if not avoided, may result in minor or moderate injury.

SYM-BOL	SIGNAL	MEANING
	CAUTION	(Without Safety Alert Symbol) Indicates a situation that may result in property damage.

3 INSTALLATION

3.1 ELECTRICAL CONNECTION

This machine has a precisely built electrical motor. It should be connected to a power supply that is 120V, 60 Hz, AC only (household). Do not operate this machine on direct current (DC). A considerable voltage drop will cause a loss of power and the motor will be overheated.

3.1.1 PREPARE A DRIP LOOP

Recommend the use of a drip loop as below so the water can not run along the power cord even possibly reach the electrical outlet and plug.

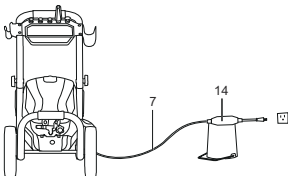

⚠ WARNING

Keep the extension cord clear of the working area. Position the cord so that it will not get caught on lumber, tools, or other obstructions while you are working with a power tool. Failure to do so can result in serious personal injury.

3.2 UNPACK THE MACHINE

⚠ WARNING

Make sure that you correctly assemble the machine before use.

⚠ WARNING

- If the parts are damaged, do not use the machine.
- If you do not have all the parts, do not operate the machine.
- If the parts are damaged or missing, speak to the service center.

1. Open the package.
2. Read the documentation in the box.
3. Remove all the unassembled parts from the box.
4. Remove the machine from the box.
5. Discard the box and package in compliance with local regulations.

3.3 INSTALL THE UPPER PANEL

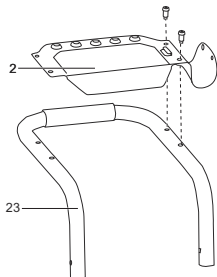

1. Align the screw sleeves of the front panel (2) with the screw holes on the upper handle (23).
2. Tighten them with a Phillips screwdriver (not included).

3.4 INSTALL THE SPRAY GUN HOLDER

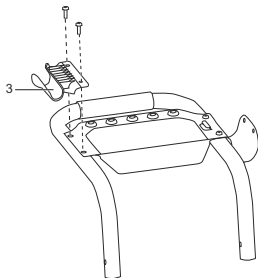

1. Align the screw sleeves of the spray gun holder (3) with the screw holes on the upper handle.
2. Tighten them with a Phillips screwdriver (not included).

3.5 INSTALL THE POWER CORD STORAGE ARMS

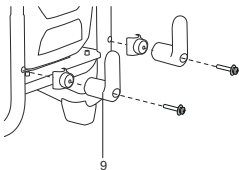

1. Attach each of the power cord storage arms (9) into the two separate positions on the lower handle of the fixture.
2. Align the screw with the holes in each of the two power cord storage arms (9).
3. Push the screw through and tighten both power cord storage arms (9) with a Phillips head screw driver (not included).

3.6 INSTALL THE UPPER HANDLE

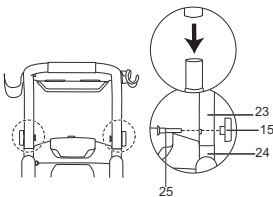

1. Align the holes on the upper handle (23) and the lower handle (24).
2. Insert the handle bolts (25) and use the handle knobs (15) to tighten them.

3.7 INSTALL THE SPRAY WAND

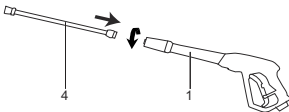

1. Push the end of the spray wand (4) into the trigger handle (1) and rotate clockwise to secure.
2. Pull on the spray wand (4) to be certain it is properly secured.

⚠ WARNING

Make sure that the connection has no leakage.

3.8 INSTALL THE HIGH PRESSURE HOSE

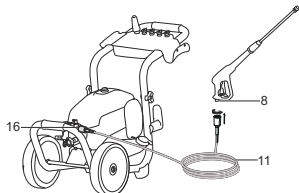

1. Push and turn clockwise one end of the high pressure hose (11) into the inlet coupler (8).
2. Install and tighten the other end of the high pressure hose onto the water outlet (16) coupler.

4 OPERATION

⚠ WARNING

Make sure that all the connections are tight and have no leakage before operation.

4.1 CONNECT THE WATER SUPPLY TO THE MACHINE

For easy operation, please use a self-coiling garden hose (not provided).

⚠ WARNING

When you operate the self-coiling hose, make sure that the hose has no blockage.

⚠ WARNING

- The water supply must come from the water main
- Do not use hot water

⚠ WARNING

Always observe all the local regulations when you connect the garden hose to the water supply. Direct connection through a receiver tank or backflow preventer is usually permitted.

⚠ CAUTION

Inspect the filter in the water inlet connector before you connect the garden hose

- If the filter is damaged, do not use the machine until the filter is replaced.
- If the filter is dirty, clean the filter.

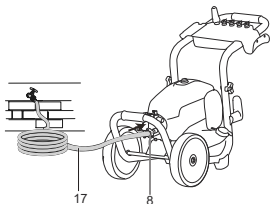

1. Uncoil the garden hose (17).
2. Let the water flow through the garden hose (17) for 30 seconds.
3. Turn the water supply off.
4. Install and tighten the end of the garden hose (17) to the water inlet (8) connector.

⚠ CAUTION

There must be a minimum of 10 feet of free hose between the water inlet and the water supply.

4.2 USE THE SPRAY GUN

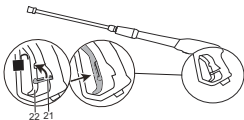

⚠ WARNING

For safe control, keep your hands on the spray gun at all times.

- Pull and hold the spray gun trigger (21) to start the machine.
- Release the spray gun trigger (21) to stop water flow through the spray tip.

4.2.1 UNLOCK THE SPRAY GUN TRIGGER

- Push the trigger safety lock-out (21) down until it clicks into the slot.

4.2.2 LOCK THE SPRAY GUN TRIGGER

- Push the trigger safety lock-out (21) up and into its original position.

4.3 CHANGE THE SPRAY TIP

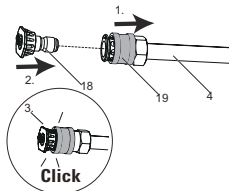

⚠ WARNING

Before you change the spray tip:





1. Pull the spray gun trigger to release water pressure.
2. Engage the trigger safety lock-out on the spray gun.
3. Stop the machine.

⚠ WARNING

Do not point the spray wand at your face or others'.

4.3.1 NOZZLE TYPE

SPRAY TIP	APPLICATION
 15°	<p>Yellow - Narrow fan tip (15°)</p> <ul style="list-style-type: none"> • The yellow pressure washer tip provides high versatility with its 15 degree angle tip. Referred to as the washing tip, because it provides adequate pressure to remove dirt from surfaces, but is designed to not damage many surfaces. This pressure washer tip is designed for "sweeping" foliage or debris given its wide angle. This tip is versatile due to its wide area of cleaning and strong pressure application.

SPRAY TIP	APPLICATION
 25°	<p>Green - Narrow fan tip (25°)</p> <ul style="list-style-type: none"> The green pressure washer tip provides high versatility with its 25 degree angle tip. Referred to as the washing tip, because it provides adequate pressure to remove dirt from surfaces, but is designed to not damage many surfaces. This pressure washer tip is designed for "sweeping" foliage or debris given its wide angle. This tip is versatile due to its wide area of cleaning and strong pressure application.
 40°	<p>White - Wide fan tip (40°)</p> <ul style="list-style-type: none"> The white 40 degree tip, referred to as the "fan" tip creates the widest area of cleaning with relatively low pressure. This pressure washer tip is best used for light or delicate cleaning applications. It is recommended for light cleaning on wood decks and other soft or delicate surfaces.
 SOAP	<p>Black - Soap spray tip</p> <ul style="list-style-type: none"> The black soap spray tip, is used for soap application. Soap is applied under low pressure high volume for optimum performance. Soap cannot be applied under high pressure with this machine.
	<p>Turbo nozzle tip</p> <ul style="list-style-type: none"> The nozzle rotates in a zero to 15 degree spray pattern in a circular motion to break down tough dirt and grime. The spray pattern can cover area of 4 to 8 inches wide, depending on a distance between the tip and the surface being cleaned.

4.3.2 INSTALL THE SPRAY TIP

- Pull back the quick-connect collar (19) on the spray wand (4).
- Insert the spray tip (18) onto the spray wand (4).
- Release the quick-connect collar (19) to attach the spray tip (18).
- Pull on spray tip (18) to ensure it is properly installed and does not pull out.

4.4 ADD DETERGENT

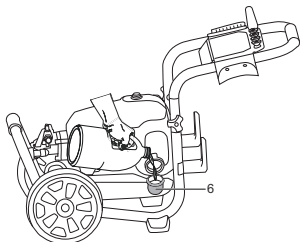

WARNING

Do not use household detergents, acids, alkalines, bleaches, solvents, flammable material, or industrial grade solutions, which can do damage to the pump.

WARNING

Read the instructions on the solution bottle to prepare detergent.

NOTE

If it is necessary, use a funnel to prevent the spill of detergent. Clean and dry the spilled detergent when you fill the tank.

NOTE

Soap/detergent can only be applied with this machine when the black nozzle(75 degree) is installed.

- Place the pressure washer upright on a flat surface.
- Open the cap on the detergent tank (6).
- Pour detergent into tank (6).
- Reinstall cap.

NOTE

Do not let detergent dry on the surface to prevent streaks.

4.5 START THE MACHINE

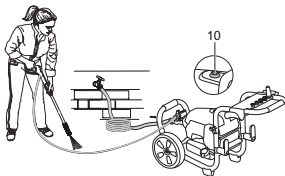

⚠ CAUTION

Do not operate without the water supply connected.

⚠ CAUTION

Before you start the machine:

1. Turn the water supply on.
 2. Pull the gun trigger to release air pressure.
 3. If a stable stream of water come into view, release the spray gun trigger.
1. Connect the machine to the power supply.
 2. Press down on the ON/OFF switch once to set the power switch to the "ON" (I) position.
 3. Turn the water supply on.
 4. Pull the spray gun trigger.
1. Release the spray gun trigger.
 2. Press down on the ON/OFF switch, once again, to set the power switch to the "OFF" (O) position.

⚠ WARNING

If you do not use the machine :

- Stop the machine.
- Turn the water supply off.
- Disconnect the power cord from the outlet.
- Pull the spray gun trigger to release the remaining pressure from the machine.
- Engage the trigger safety lock-out on the spray gun.

4.7 THERMAL RELIEF VALVE FUNCTION

The thermal relief valve is a thermal protector for the pressure washer pump. This pump feature will prevent water temperatures from reaching harmful levels by releasing a small amount of water. Opening temperature is 140°F. The valve will reset automatically once the pump relieves.

5 MAINTENANCE

⚠ WARNING

Before maintenance, make sure that you

- Stop the machine.
- Wait until all the moving parts stop.
- Disconnect the plug from the power source.

⚠ WARNING

Do not use strong solvents or detergents on the plastic housing or components.

⚠ WARNING

Do not let brake fluids, gasoline, petroleum-based materials touch the plastic parts. Chemicals can cause damage to the plastic, and make the plastic unserviceable.

⚠ WARNING

Replace the power cord by an approved service center.

5.1 SPRAY TIP MAINTENANCE

⚠ WARNING

Never point the spray wand at your face.

5.1.1 REMOVE THE SPRAY TIP

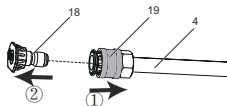

1. Pull back the quick-connect collar (19) on the spray wand (4).
2. Remove the spray tip (18) from the spray wand (4).

5.1.2 CLEAN THE SPRAY TIP

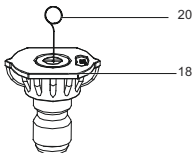

1. Use a straight paper clip or cleaning tool (20) to clean the spray tip.
2. Flush and clean the unwanted materials out of the spray tip (18) with the garden hose (17).
3. Install the clean spray tip (18) back into the spray wand (4).

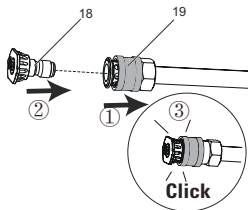

6 TRANSPORTATION AND STORAGE

⚠ WARNING

Disconnect the power cord and water supply hose before transportation and storage.

6.1 MOVE THE MACHINE

- Point the spray wand in a safe direction.
- Only hold the machine with the handgrip.

6.2 STORE THE MACHINE

⚠ WARNING

Make sure that the spray gun, the high pressure hose and the machine are dry.

⚠ WARNING

Make sure the machine is out of the reach of children.

- Disconnect the garden hose from machine.
- Wind the power cord and the high-pressure hose.

- Clean housing and the plastic components with a moist and soft cloth.
- Make sure that the machine does not have loose or damaged parts. If it is necessary, follow these steps/instructions:
 - Replace the damaged parts.
 - Tighten the bolts.
 - If needed, call the customer service phone number for servicing instructions.
- Store the machine in a dry, isolated and frost-free area.

7 TROUBLESHOOTING

PROBLEM	POSSIBLE CAUSE	SOLUTION
The motor does not start.	The power button is in the "OFF" (O) position.	Set the power switch to the "ON" (I) position.
	The power cord is not plugged in.	Connect the power cord to the power supply.
	Electrical outlet does not supply sufficient power.	Try another electrical outlet.
	The circuit breaker is tripped.	Let it cool, and start the machine again.
	The power switch is on, but you do not pull the spray gun trigger.	Pull the spray gun trigger.

PROBLEM	POSSIBLE CAUSE	SOLUTION
The machine does not reach high pressure.	The diameter of garden hose is too small.	Replace with a 1" (25 mm) or 5/8" (16 mm) garden hose.
	Water supply is restricted.	Check garden hose for kinks, leaks, and blockage.
	The water supply is not sufficient.	Open the water supply fully.
	Spray tip has not been installed onto the spray wand properly.	Install desired spray tip to end of wand.
	The water intake filter is clogged.	Remove filter and rinse in warm water.

PROBLEM	POSSIBLE CAUSE	SOLUTION
The output pressure varies high and low.	The water supply is not sufficient.	Open water supply fully. Check garden hose for kinks, leaks, or blockage.
	The pump is drawing in air.	<ol style="list-style-type: none"> 1. Make sure that the hoses and fitting are airtight. 2. Turn "OFF" machine. 3. Purge pump by squeezing trigger gun until a steady flow of water comes out the spray tip.
	The water intake filter is clogged.	Remove the filter and Rinse in warm water.
	The supply voltage is low.	Make sure that only the pressure washer is running on the circuit.
	The gun, hose or nozzle are calcified.	Run distilled vinegar through detergent tank.

PROBLEM	POSSIBLE CAUSE	SOLUTION
The motor buzzes, but the machine does not start.	The supply voltage is low.	Make sure that only the pressure washer is running on the circuit.
	The pump system has residual pressure.	<ol style="list-style-type: none"> 1. Turn "OFF" the machine. 2. Pull the spray gun trigger on spray wand to release pressure. 3. Turn the machine "ON".
	Voltage loss due to use of an improper extension cord.	Disconnect the extension cord, and connect the machine directly into the outlet.
	Pressure washer not used for long periods.	Call customer service.
There is no water.	The water supply is off.	Turn the water supply on.
	The garden hose is kinked.	Remove kink in garden hose.
	Residual friction among components. Unit might emit a humming noise.	<ol style="list-style-type: none"> 1. Disconnect the water supply. 2. Power "ON" the machine for 2 to 3 seconds. 3. Repeat the above step a couple of times or until the motor starts.

8 TECHNICAL DATA

Universal Motor	120V~ 60 Hz, 14 Amps
-----------------	----------------------

Max. Pounds Per Square Inch Pressure	3000 PSI
Rated Gallons Per Minute	1.1 GPM
Maximum Inlet Water Temperature	104 °F (40 °C)
Cleaning Units	3300 C.U.
	Double-insulated construction.

9 LIMITED WARRANTY

90-Day Warranty

Renewed/Refurbished products and batteries are protected against all defects in materials, parts or workmanship under normal use for a period of 90 days from the shipping date or in-store purchase date. All sales are final, no returns.

ITEMS NOT COVERED BY WARRANTY:

1. Any part that has become inoperative due to misuse, commercial use, abuse, neglect, accident, improper maintenance, or alteration; or
2. The unit, if it has not been operated and/or maintained in accordance with the owner's manual; or
3. Normal wear, except as noted below;
4. Routine maintenance items such as lubricants, blade sharpening;
5. Normal deterioration of the exterior finish due to use or exposure.

HELPLINE:

Warranty service is available by calling our toll-free helpline, at 1-855-345-3934.

TRANSPORTATION CHARGES:

Transportation charges for the movement of any power equipment unit or attachment are the responsibility of the purchaser. It is the purchaser's responsibility to pay transportation charges for any part submitted for

replacement under this warranty unless such return is requested in writing by Greenworks.

USA address:

Greenworks Tools

P.O. Box 1238

Mooresville, NC 28115

Canadian address:Greenworks Tools Canada
Inc.P.O. Box 93095, Newmar-
ket, Ontario

L3Y 8K3

10 EXPLODED VIEW

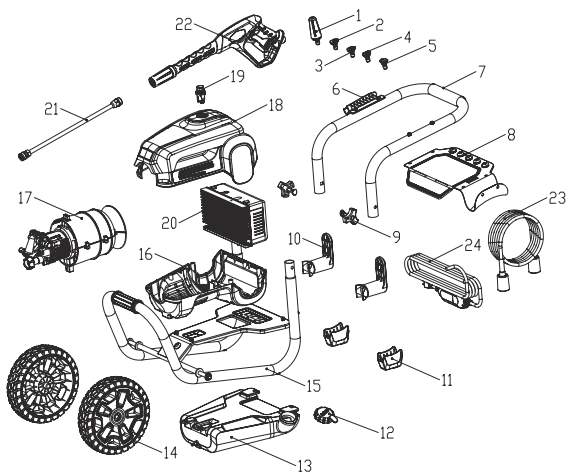

ITEM NO.	PART NO.	DESCRIPTION	QTY
1	31202994	Turbo Nozzle	1
2	34139319	Soap Tip	1
3	C1105632-00	40° spray Tip	1
4	C1102282-00	25° spray Tip	1
5	C1105300-00	15° spray Tip	1
6	C4102637-00	Spray Gun Holder	1
7	C3202763-00	Upper Handle	1
8	C3200441-00	Nozzle Storage Panel Assembly	1
9	3410835-4	Nut	2
10	C4100809-00	Power Cord Storage	2
11	C4102172-00	Frame Foot Pad	2
12	C4100527-00	Detergent Tank Cap	1
13	C4100486-00	Detergent Tank	1
14	341301936AE	Wheel Assembly	2
15	C3202764-00	Lower Handle	1

16	C4104463-00	Lower Housing	1
17	C1105033-00	Motor Assembly	1
18	C4104462-00	Upper Housing	1
19	C6200015-00	Power Switch	1
20	C1104424-00	PCB Board	1
21	C1104485-00	Spray Wand	1
22	C1104426-00	Spray Gun	1
23	C1108834-00	High Pressure Hose	1
24	C6300328-00	Power cord assembly (with GFCI)	1

greenworks[®]

www.greenworkstools.com



P0804188-01