

# greenworks<sup>®</sup>

GPW2000A  
GPW2000FCA  
GPW2000FCSC

EN

PRESSURE WASHER

OPERATOR MANUAL

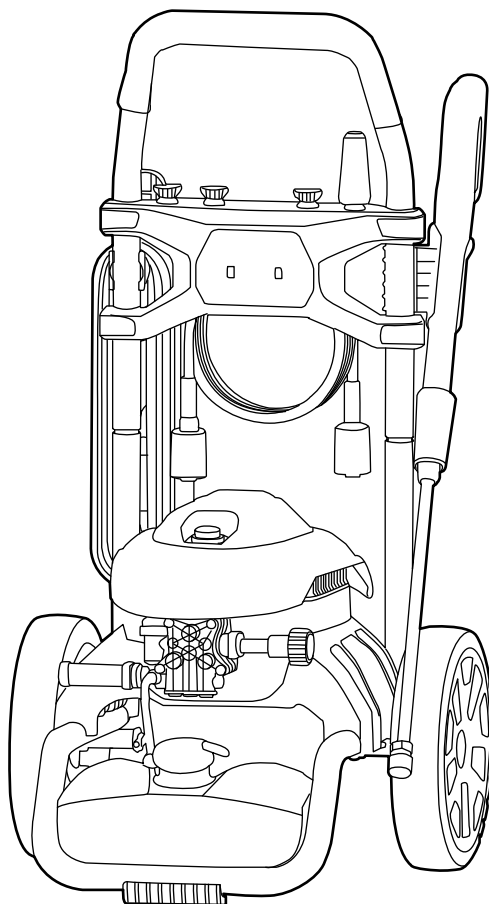

PWA113

[www.greenworkstools.com](http://www.greenworkstools.com)



<b>1</b>	<b>Product description.....</b>	<b>4</b>	7.9	Install the spray wand.....	8
<b>2</b>	<b>Intended use.....</b>	<b>4</b>	7.10	Spray tips and turbo nozzle.....	9
<b>3</b>	<b>Product overview.....</b>	<b>4</b>	<b>8</b>	<b>Operation.....</b>	<b>9</b>
<b>4</b>	<b>Symbols on the product.....</b>	<b>4</b>	8.1	Before you start.....	9
<b>5</b>	<b>California Proposition 65.....</b>	<b>5</b>	8.2	Start the product.....	10
<b>6</b>	<b>Safety.....</b>	<b>5</b>	8.3	Stop the product.....	10
6.1	Safety definitions.....	5	<b>9</b>	<b>Maintenance.....</b>	<b>11</b>
6.2	Inspect safety features.....	5	9.1	Clean debris.....	11
6.3	Safety instructions for maintenance.....	6	9.2	Check and clean the water inlet screen.....	11
<b>7</b>	<b>Assembly.....</b>	<b>6</b>	9.3	Check the high-pressure hose.....	11
7.1	Install the front panel & spray tips & turbo nozzle .....	6	9.4	Check the spray gun.....	11
7.2	Install the hose hook.....	6	9.5	Spray tip maintenance.....	11
7.3	Install the power cord hook.....	7	9.6	Recommended Pump Care.....	11
7.4	Install the spray gun holder.....	7	<b>10</b>	<b>Transportation and storage.....</b>	<b>12</b>
7.5	Install the upper handle.....	7	10.1	Transport the product.....	12
7.6	Install the wheels.....	7	10.2	Winter and long-term storage.....	12
7.7	Install the high-pressure hose.....	8	<b>11</b>	<b>Troubleshooting.....</b>	<b>13</b>
7.8	Connect the water supply to the product.....	8	<b>12</b>	<b>Technical data.....</b>	<b>14</b>
			<b>13</b>	<b>Limited warranty.....</b>	<b>14</b>

## 1 PRODUCT DESCRIPTION

This product is a corded pressure washer with an electric motor.

We are committed to continuously improving our products and reserve the right to modify the design and appearance without prior notice.

## 2 INTENDED USE

The product is designed for outdoor home use only. It includes various spray tips and a turbo nozzle that serve different purposes. It is intended to clean: machines, vehicles, buildings, floors, tools, facades, terraces, floors, and concrete walkways by removal of stubborn dirt using clean water with or without cleaning detergent. Do not use the product for any other purposes.

## 3 PRODUCT OVERVIEW

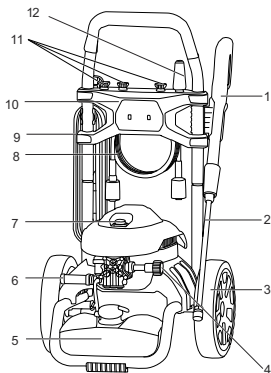

- |   |                |    |                    |
|---|----------------|----|--------------------|
| 1 | Spray gun      | 8  | High-pressure hose |
| 2 | Spray wand     | 9  | Power cord         |
| 3 | Wheel          | 10 | Front panel        |
| 4 | Water inlet    | 11 | Spray tips         |
| 5 | Detergent tank | 12 | Turbo nozzle       |
| 6 | Water outlet   |    |                    |
| 7 | Power button   |    |                    |

## 4 SYMBOLS ON THE PRODUCT

Symbol	Explanation
	Carefully read and understand instructions before operating the product and follow all warnings and safety instructions.
	Do not expose the product to rain or moist conditions.
	Always wear safety goggles or safety glasses with side shields and, as necessary, a full-face shield when operating this product.
	To reduce the risk of high-pressure injection or injury, never direct a water stream towards people or pets or place any body part in the stream. Leaking hoses and fittings can also cause injury. Do not place hands near high-pressure stream.
	To reduce the risk of injury from kickback, hold the spray gun securely with both hands when the product is on.
	Failure to operate in dry conditions and neglecting safe practices can increase risk of electric shock.
	Burst hazard.
	Warning! Never aim the spray gun at humans, animals, the product, power supply, or any electrical appliances.
	The product is not suitable for connection to the drinking water mains without backflow preventer.
	Only set product on flat, horizontal surfaces. Never lift product during operation.
	Keep hands and feet away from the cleaning area while the product is running.

**5 CALIFORNIA PROPOSITION 65****⚠ WARNING**

This product contains or emits a chemical known to the State of California to cause cancer or birth defects or other reproductive harm.

**6 SAFETY****6.1 SAFETY DEFINITIONS**

Warnings, cautions, and notes are used to point out especially important parts of the manual.

**⚠ WARNING**

Used if there is a risk of injury or death for the operator or bystanders, if the instructions in the manual are not obeyed.

**⚠ CAUTION**

Used if there is a risk of damage to the product, other materials, or the adjacent area, if the instructions in the manual are not obeyed.

**Note:** Used to give more information that is necessary in a given situation.

**6.1.1 IMPORTANT SAFETY INSTRUCTIONS****⚠ WARNING**

When using this product basic precautions should always be followed, including the following:

1. Read all the instructions before using the product.
2. To reduce the risk of injury, close supervision is necessary when a product is used near children.
3. Know how to stop the product and bleed pressures quickly. Be thoroughly familiar with the controls.
4. Stay alert – watch what you are doing.
5. Do not operate the product when fatigued or under the influence of alcohol or drugs.
6. Keep operating area clear of all persons.
7. Do not overreach or stand on unstable support. Keep good footing and balance at all times.
8. Follow the maintenance instructions specified in the manual.
9. **WARNING – Risk of Injection or Injury– Do Not Direct Discharge Stream At Persons.**

**6.1.2 GROUNDING FAULT CIRCUIT INTERRUPTER PROTECTION**

- The product is equipped with a ground fault circuit interrupter (GFCI) built into the power cord plug.
- The GFCI provides additional protection from the risk of electric shock.
- If you need to replace the plug or cord, ensure that you only use identical replacement parts that include GFCI protection.

**6.1.3 SERVICING OF A DOUBLE INSULATED APPLIANCE**

- In a double-insulated product, two systems of insulation are provided instead of grounding.
- A double-insulated product does not have a grounding mechanism included, nor should any means for grounding be added to the product.
- Servicing a double-insulated product requires extreme care and knowledge of the system, and should be done only by qualified service personnel.
- Replacement parts for a double-insulated product must be identical to the parts they replace.
- A double-insulated product is marked with the words "DOUBLE-INSULATION" or "DOUBLE-INSULATED." The symbol is

**6.1.4 EXTENSION CORD(S)**

- Use only extension cord(s) that are intended for outdoor use.
- These extension cord(s) are identified by a marking "Acceptable for use with outdoor appliances; store indoors while not in use."
- Use only extension cord(s) marked with an electrical rating not less than the rating of the product.
- Do not use damaged extension cord(s).
- Examine extension cord(s) before using and replace if damaged.
- Do not abuse extension cord(s) and do not yank on any cord(s) to disconnect.
- Keep cord(s) away from heat and sharp edges.
- Always disconnect the extension cord(s) from the power strip before disconnecting the product from the extension cord(s).
- **WARNING – To reduce the risk of electrocution, keep all connections dry and raised above the ground.**
- Do not touch electric plug with wet hands.

**6.2 INSPECT SAFETY FEATURES**

### 6.2.1 CHECK THE SPRAY GUN

- If the spray gun trigger depresses without pressing safety lock or if the spray gun remains depressed when released, replace the spray gun immediately.

### 6.2.2 CHECK THE HIGH-PRESSURE HOSE

- If the high-pressure hose is damaged, replace immediately.

### 6.2.3 CHECK THE WATER INLET SCREEN

Inspect the inlet screen. Remove debris or replace if damaged.

### 6.3 SAFETY INSTRUCTIONS FOR MAINTENANCE

#### ⚠ WARNING

Read the warning instructions that follow before you do maintenance on the product.

- Before inspecting, cleaning, or servicing the product, shut off the product, wait for all moving parts to stop, disconnect the product from the power supply, and squeeze the spray gun trigger to release water pressure. Failure to follow these instructions can result in serious personal injury or property damage.
- When servicing, use only identical replacement parts. Use of any other parts could create a hazard or cause product damage.
- Periodically inspect the entire product for damaged, missing, or loose parts such as screws, nuts, bolts, caps, etc. Securely tighten all fasteners and caps and do not operate this product until all missing or damaged parts are replaced. Please call customer service or contact an authorized service center for assistance.
- Avoid using solvents when cleaning plastic parts. Most plastics are susceptible to damage from various types of commercial solvents and may be damaged by their use. Use clean cloths to remove dirt, dust, oil, grease, etc.
- Do not at any time let brake fluids, gasoline, petroleum-based products, penetrating oils, etc., come in contact with plastic parts. Chemicals can damage, weaken, or destroy plastic which could result in serious personal injury.
- Neglecting regular maintenance decreases the life cycle of the product and increases the risk of accidents.
- Special training is necessary for all servicing and repair work, especially for the safety features on the product. If not all checks in this operator's manual are approved after maintenance, speak to your servicing dealer. We guarantee that there are professional repairs and servicing available for your product.

## SAVE THESE INSTRUCTIONS

### 7 ASSEMBLY

This section describes how to assemble and adjust the product.

#### ⚠ WARNING

Carefully read and understand the safety chapter and the assembly instructions before you assemble the product.

#### 7.1 INSTALL THE FRONT PANEL & SPRAY TIPS & TURBO NOZZLE

1. Insert the spray tips and turbo nozzle into the front panel.
2. Mount the front panel onto the rear side of the upper handle.

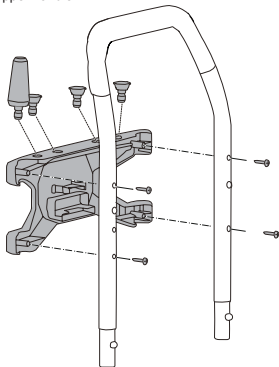

3. Secure the front panel with screws.

#### 7.2 INSTALL THE HOSE HOOK

Push the hose hook ends into the clips behind the front panel.

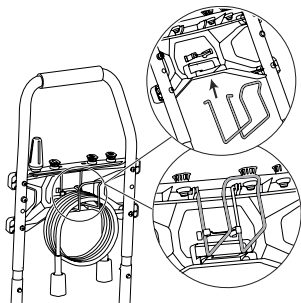

### 7.3 INSTALL THE POWER CORD HOOK

1. Mount the power cord hook and fixture onto the upper handle.

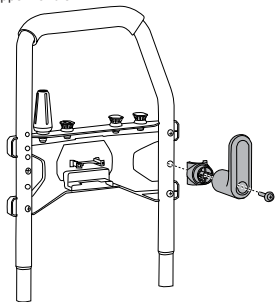

2. Secure the power cord hook and fixture with the screw.

### 7.4 INSTALL THE SPRAY GUN HOLDER

1. Align the screw sleeves of the spray gun holder with the screw holes on the upper handle.
2. Push the screws through the screw sleeves and tighten them.

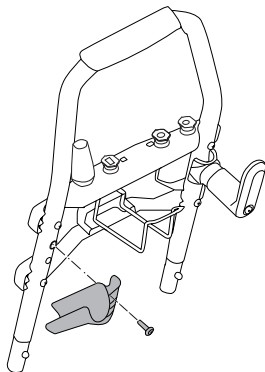

### 7.5 INSTALL THE UPPER HANDLE

1. Press and hold the handle lock buttons on the upper handle.
2. Slide the upper handle into the lower handle until the lock buttons pass through the locking slot to secure the upper handle in place.

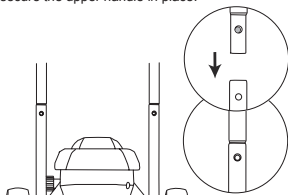

### 7.6 INSTALL THE WHEELS

1. Slide the wheel over the axle stud (1).
2. Lift corner of the pressure washer slightly. Tilt the product and slide the axle stud (1) through mounting bracket (3) below the frame.
3. Slide the flat washer (2) over the axle stud (1).
4. Insert the retaining pin (4) through the hole on the axle stud to secure the wheel in place.

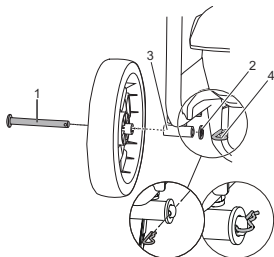

- Repeat steps 1 through 4 for the other side.

### 7.7 INSTALL THE HIGH-PRESSURE HOSE

- Uncoil the high pressure hose and attach the end of hose to base of spray gun. Tighten by hand.

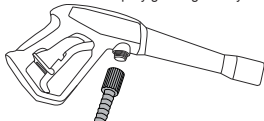

- Attach the other end of the high pressure hose to the high pressure outlet on pump. Tighten by hand.

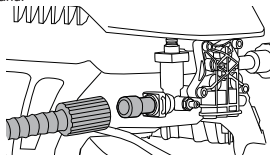

### 7.8 CONNECT THE WATER SUPPLY TO THE PRODUCT

#### CAUTION

- The water supply must come from the water main.
- Do not use hot water.
- Do not use water from ponds or lakes.

#### CAUTION

Before connecting the garden hose (not included) to water inlet :

- Run water through the garden hose for 30 seconds to clean any debris from the hose. Turn off water.
- Inspect the screen in the water inlet.
  - If the screen is damaged, do not use the product until the screen has been replaced.
  - If the screen is dirty, clean it before connecting the garden hose to the product.

- Uncoil the garden hose to prevent kinks.
- Connect the garden hose to the water inlet and tighten securely by hand.

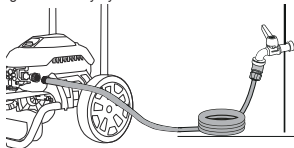

#### CAUTION

There MUST be at least 10 ft. (3 m.) of unrestricted garden hose between the water inlet and the water supply.

### 7.9 INSTALL THE SPRAY WAND

#### CAUTION

Before connecting the spray wand, you should turn on water, point spray gun in safe direction, unlock and press trigger to purge pump system of air and impurities.



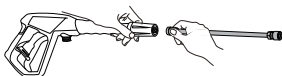

Attach the spray wand to the spray gun. Tighten by hand.





## 7.10 SPRAY TIPS AND TURBO NOZZLE

## 7.10.1 SELECT DESIRED SPRAY TIP OR TURBO NOZZLE:

Name	Picture	Description
Turbo Nozzle		High-pressure for blasting hard-to-clean stains, tar, glue, etc.
Green 25° Spray tip		Medium-pressure for washing or removing dirt, mud, stains, etc.
White 40° Spray tip		Medium-low pressure for rinsing and light cleaning of windows, roofs, boats, etc.
Black Spray tip		Low-pressure soap/detergent application.

## 7.10.2 INSTALL THE SPRAY TIP

1. Pull back and hold the spray wand quick connect collar.

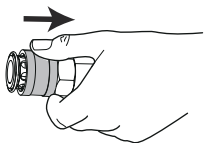

2. Insert the required spray tip.



3. Release the quick-connect collar to lock the spray tip in place.

**Note:** Tug on the spray tip to make sure it is securely in place.

## 8 OPERATION

This section describes how to operate the product.

 WARNING

CAREFULLY READ AND UNDERSTAND THE SAFETY CHAPTER AND OPERATION INSTRUCTIONS BEFORE YOU OPERATE THE PRODUCT.

## 8.1 BEFORE YOU START

## 8.1.1 PREPARE A DRIP LOOP

A drip loop is an important safety measure that prevents water from dripping into the electrical outlet. To set up a drip loop, use an object to elevate the part of the cable closest to the outlet, in order to create a downward droop. This droop will help ensure that any water running down the cable is directed away from the outlet. Use a cable clip to secure drip loop in place.

 WARNING

Failure to prepare a drip loop can result in serious injury and/or property damage.

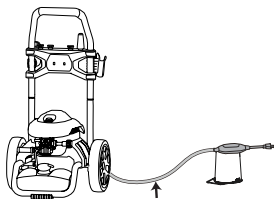
 WARNING

Ensure that the extension cord remains clear of the working area. Position the cord in a manner that prevents it from getting entangled with lumber, tools, or other obstructions while operating a product. Failure to do so may result in severe personal injury or death.

## 8.1.2 ADD DETERGENT

 CAUTION

Only use soaps/detergents that are specifically designed for pressure washers. Do not use household detergents, acid, alkaline, bleaches, solvents, flammable materials, or industrial-grade solutions, which can damage the product.

**Note:**

- Use a funnel to prevent spilling detergent. Clean and dry any spilled detergent to prevent accidental slips or falls.
- Soap/detergent can only be applied with this product when the black soap spray tip is installed.

1. Ensure the product is on a flat surface.
2. Remove cap from detergent tank and fill the tank with detergent solution.

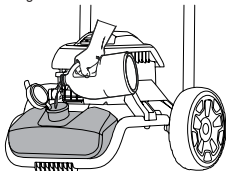

3. Close the cap.

## 8.2 START THE PRODUCT

**Note:** The product should be connected to a power supply that is 120V, 60 Hz, AC only (household). A considerable voltage drop will cause a loss of power and the motor will overheat.

### ⚠ CAUTION

DO NOT start the product without the water supply connected and turned on, as this will harm the pump.

1. Plug the power cord into a compatible electrical outlet.



2. Turn on the water supply.
3. Press the power button once to start the product.

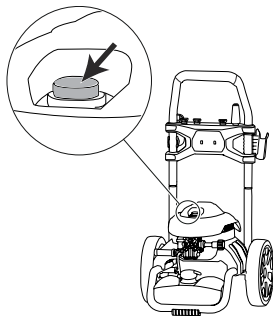

4. Point the spray gun in a safe direction. Disengage the trigger safety lock and pull the trigger.

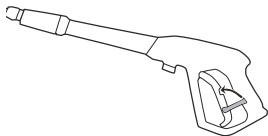

### ⚠ WARNING

Hold the spray gun securely with both hands. Expect the spray gun to move when the trigger handle is squeezed due to reaction forces. Failure to do so could cause loss of control and injury to yourself and others.

## 8.3 STOP THE PRODUCT

1. Release the spray gun trigger.
2. Pull down the trigger safety lock until it clicks into the slot.

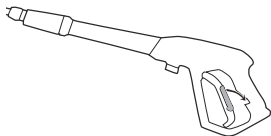

3. Push the power button to stop the product.
4. Turn off the water supply.
5. Disconnect the power cord from the outlet.

**Note:** If you do not use the product, point the spray gun in a safe direction, and squeeze the trigger to relieve built-up pressure in the product.

## 9 MAINTENANCE

### IMPORTANT

Carefully read and understand the safety regulations and the maintenance instructions before you clean, repair, or do any maintenance work on the product.

### 9.1 CLEAN DEBRIS

Clean accumulated debris from the product daily or before each use. Regularly inspect the openings on the front, rear, and bottom of the product, ensuring they remain clean and unobstructed. Clean the product exterior with a damp cloth. Keeping the product clean is crucial to minimize the risk of overheating and ignition caused by accumulated debris.

**Note:** Improper handling or treatment of the product can result in damage and/or reduced lifespan.

### 9.2 CHECK AND CLEAN THE WATER INLET SCREEN

Examine the screen on the product's water inlet. Clean it if the screen is clogged or replace it if damaged.

### 9.3 CHECK THE HIGH-PRESSURE HOSE

The high-pressure hose may develop leaks due to wear, kinking, or misuse. Before each use, thoroughly inspect the hose for cuts, leaks, abrasions, bulging of the cover, or damage to the couplings. If any of these conditions are present, replace the hose immediately.

### WARNING

- Never attempt to repair a high-pressure hose. Always replace it.
- The replacement hose must have a rating that is equal to or exceeds the maximum pressure rating of the product.

### 9.4 CHECK THE SPRAY GUN

1. Examine hose connection to the spray gun and make sure it is secure.
2. Test the trigger by squeezing it and making sure it springs back into place when you release it.
3. Engage the safety lock and test the trigger. You should not be able to squeeze the trigger.
4. Replace the spray gun immediately if it fails any of these tests.

### 9.5 SPRAY TIP MAINTENANCE

If you experience a pulsing sensation while squeezing the spray gun trigger, it may be due to excessive pump pressure. The main cause of excessive pump pressure

is often a clogged spray tip or a restriction caused by foreign materials, such as dirt

### 9.5.1 REMOVE THE SPRAY TIP

**Note :**

- Before removing the spray tip, you should turn off the power switch and remove the power cord plug from electrical outlet.
- Disconnect water supply to the product.
- ALWAYS point the spray gun in a safe direction, push the trigger safety lock up and squeeze the trigger to release retained water pressure.

1. Pull back and hold the quick-connect collar on the spray wand.

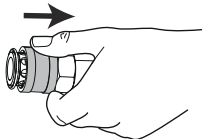

2. Remove the spray tip from the spray wand.



### 9.5.2 CLEAN THE NOZZLE

1. Use a small paper clip to free any foreign material clogging or restricting the spray tip.

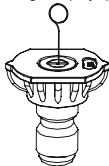

2. Using a garden hose, flush debris out of spray tip by back flushing (running the water through the spray tip backward or from the outside to the inside).
3. Reinstall the spray tip to the spray wand.

### 9.6 RECOMMENDED PUMP CARE

- Regularly using pump protector solution (not included) can help extend the lifespan of the product. It aids in the removal of hard water mineral

deposits, lubricates pump seals and pistons, and prevents freeze damage.

- To maintain the best performance of the product, pump protector should be added to the product after every use and before long-term storage.

**Note:** The following steps are typical for adding pump protector to the product. Always read the specific instructions provided by the manufacturer of the pump protector used before starting.

- Turn the water tap off and make sure the product is powered off.
- Press the spray gun trigger for approximately 1 minute or until no more water discharges from the connected accessory.
- Disconnect the power cord from the outlet.
- Disconnect the hose from the water inlet.
- Remove the cap from pump protector bottle and insert the pump protector spout into the water inlet.
- Turn the water inlet sleeve to secure the connection.
- Squeeze the pump protector bottle to inject protector fluid into the product.
- The procedure is complete when the protector fluid discharges from the water outlet.

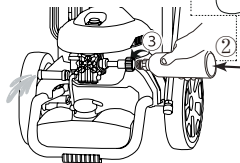

## 10 TRANSPORTATION AND STORAGE



### WARNING

Disconnect the power cord and water supply hose before transportation and storage.

### 10.1 TRANSPORT THE PRODUCT

- Drain all the water from the product, high-pressure hose, spray wand, spray gun and detergent tank.

- Neatly wind the power cord onto the power cord hook.
- Place the spray gun into the spray gun holder.
- Cover the water inlet with the cover cap.
- Dry the nozzle or spray tips and insert them into the storage area.
- Always use the upper handle to move the product.
- When transporting the product in a vehicle, securely fasten it using suitable bungee cords or similar restraints to prevent damage.

## 10.2 WINTER AND LONG-TERM STORAGE

### 10.2.1 WINTER STORAGE

**Note:** Proper preparation for winter storage can prolong the lifespan of the product.

- Ensure the spray gun, high-pressure hose, water inlet, and water outlet are dry. Wipe the product dry.
- Neatly wind the power cord onto the power cord hook.
- Use a pump protector solution to safeguard against cold weather damage during winter storage. Refer to the Pump Maintenance chapter for further details.
- Disconnect the garden hose from water inlet.
- Wind the high-pressure hose and hang it on the hose hook.
- Clean the product housing and the accessories with a soft, damp cloth.
- Store the product in a dry, isolated room temperature and frost-free area.

### 10.2.2 LONG TERM STORAGE

**Note:** Do not store the product in an area with ambient temperature below 32°F (0°C). Water should not remain in the product for long periods. Sediment or minerals can deposit on pump parts and freeze the pump. Follow these procedures after every use:

- Refer to steps 1-5 in the previous section TRANSPORT THE PRODUCT.
- Store the product and its accessories in a frost-free room. Keep them in a dry area away from children and pets.

## 11 TROUBLESHOOTING

PROBLEM	POSSIBLE CAUSE	POSSIBLE SOLUTION
The motor does not start.	The power switch is off.	Press the power switch to turn on the product.
	The power cord is not plugged in.	Connect the power cord to the power supply.
	Electrical outlet does not supply sufficient power.	Try another electrical outlet.
	The circuit breaker is tripped.	Let it cool, and start the product again.
	The power switch is on, but you did not squeeze the spray gun trigger.	Squeeze the spray gun trigger.
The product does not reach high pressure.	The diameter of garden hose is too small.	Replace with a 1" (25 mm) or 5/8" (16 mm) garden hose.
	Water supply is restricted.	Check garden hose for kinks, leaks, and blockages.
	Water supply is not sufficient.	Increase the water supply.
	Spray tip is not properly installed onto the spray wand.	Install desired spray tip to end of wand.
	The water intake filter is clogged.	Remove filter and rinse in warm water.
The output pressure varies( high and low)	The water supply is not sufficient.	Increase water supply. Check garden hose for kinks, leaks, or blockages.
	The pump is drawing in air.	<ol style="list-style-type: none"> <li>1. Make sure that the hoses and fittings are airtight.</li> <li>2. Turn off the product.</li> <li>3. Purge pump by squeezing spray gun trigger until a steady flow of water comes out from the spray tip.</li> </ol>
	The water intake filter is clogged.	Remove the filter and rinse in warm water.
	The supply voltage is low.	Make sure that only the product is running on the circuit.
	The gun, hose, or nozzle are calcified.	Run distilled vinegar through detergent tank.
The motor buzzes, but the product does not start.	The supply voltage is low.	Make sure that only the product is running on the circuit.
	The pump system has residual pressure.	<ol style="list-style-type: none"> <li>1. Turn off the product.</li> <li>2. Squeeze the spray gun trigger on spray wand to release pressure.</li> <li>3. Turn on the product.</li> </ol>

PROBLEM	POSSIBLE CAUSE	POSSIBLE SOLUTION
	Voltage loss due to use of an improper extension cord.	Disconnect the extension cord, and connect the product directly into the outlet.
	The product can't be used for long periods.	Call customer service.
	Residual friction of components may produce a humming noise.	<ol style="list-style-type: none"> <li>1. Disconnect the water supply.</li> <li>2. Power on the product for 2 to 3 seconds.</li> <li>3. Repeat the above step a couple of times until the motor starts.</li> </ol>
There is no water.	The water supply is off.	Turn the water supply on.
	The garden hose is kinked.	Remove kink(s) in garden hose.

## 12 TECHNICAL DATA

Voltage	120 V~ 60 Hz, 14 Amps
Max. Pounds Per Square Inch Pressure	2000 PSI
Rated Gallons Per Minute	1.2 GPM
Maximum Inlet Water Temperature	104 °F (40 °C)
Cleaning Units	2,400 C.U.
	Double-insulated construction.

## 13 LIMITED WARRANTY

### 90-Day Warranty

Renewed/Refurbished products and batteries are protected against all defects in materials, parts or workmanship under normal use for a period of 90 days from the shipping date or in-store purchase date. All sales are final, no returns.

### ITEMS NOT COVERED BY WARRANTY:

1. Any part that has become inoperative due to misuse, commercial use, abuse, neglect, accident, improper maintenance, or alteration; or
2. The unit, if it has not been operated and/or maintained in accordance with the operator manual; or
3. Normal wear;
4. Routine maintenance items such as lubricants, blade sharpening;
5. Normal deterioration of the exterior finish due to use or exposure.

### HELPLINE:

Warranty service is available by calling our toll-free helpline at 1-888-909-6757.

### TRANSPORTATION CHARGES:

Transportation charges for the movement of any power equipment unit or attachment are the responsibility of the purchaser. It is the purchaser's responsibility to pay transportation charges for any part submitted for replacement under this warranty unless such return is requested in writing by Greenworks.

**USA address:**

Greenworks Tools

P.O. Box 1238, Mooresville, NC 28115

**Canadian address:**

Greenworks Tools Canada, Inc.

P.O. Box 93095, Newmarket, Ontario, L3Y 8K3

**Mexico address:**

TECNOLOGIA CAMPO Y JARDIN S.A. DE C.V.

ADMINISTRADORES No. 5336 A, COL. ARCOS DE  
GUADALUPE, ZAPOPAN , JALISCO , C.P. 45037

# greenworks<sup>®</sup>

[www.greenworkstools.com](http://www.greenworkstools.com)

